

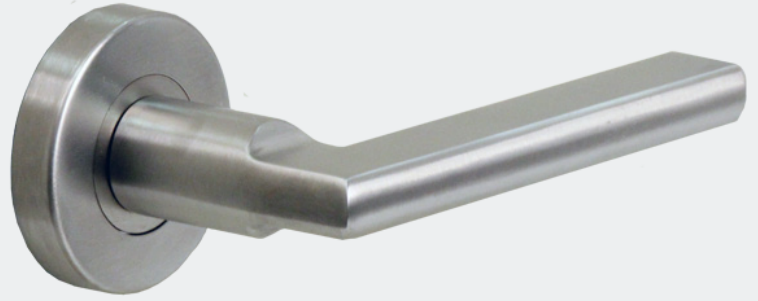

AC480

DOOR LEVER



SPECIFICATIONS

FINISHES

629 - Polished Stainless
630 - Satin Stainless

SERIES

Postmodern

MODEL

AC480

FUNCTIONS

PA - Passage
PR - Privacy
DU - Dummy

BACKSETS

2 3/8"
2 3/4"

ROSE OPTIONS

RD

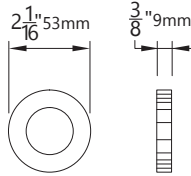

RD161

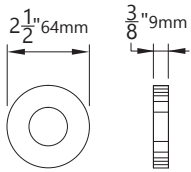

SQ

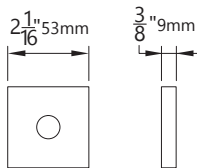

SQ161

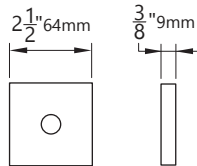

DIMENSIONS

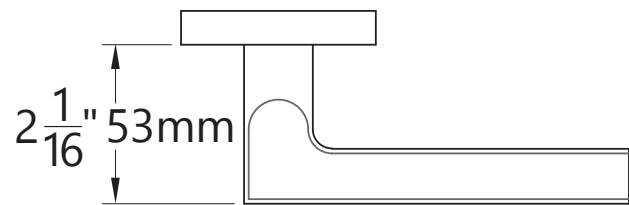
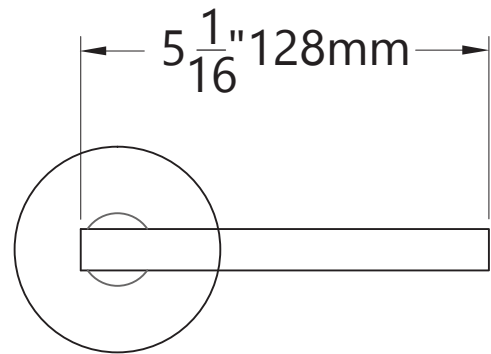

Architectural
Concepts

O (888) 248 2724
D (720) 259 5364
E info@archconceptsllc.com

18505 Longs Way
Parker, CO 80134

archconceptsllc.com

NOTE: If installing on an existing 2-1/8" bore, you will need to use the RD161 or SQ161 to cover the face hole properly.