

# Architectural Concepts

Shower Enclosures



# SHOWER ENCLOSURES

Architectural Concepts offers modern styling in a variety of shower designs utilizing our own glass hardware to produce a unique series of shower enclosures

## BARN

Modern, minimal and simple design provides a clean and luxurious feel to a room where functionality is understated. Convenient when space is a premium, we provide two options and four finishes.

Newport  
Monterey

## BY-PASS

Innovative, custom quality engineering, delivering a beautiful appearance to any bathroom with space-saving needs. We have three design options and four finishes to choose from.

Santa Cruz  
Pasadena  
Fresno  
Sonoma  
Calistoga

## SWING

We offer hinged and pivot options in our Swing shower collection. Made entirely of glass, our swing showers display an elegant and fresh aesthetic to your bath.

Malibu  
Fremont  
Industry



Our **AC<sup>2</sup>** glass is available in Low iron, dual-sided hydrophobic coated that repels water and cleans easily.

*Contact for availability.*



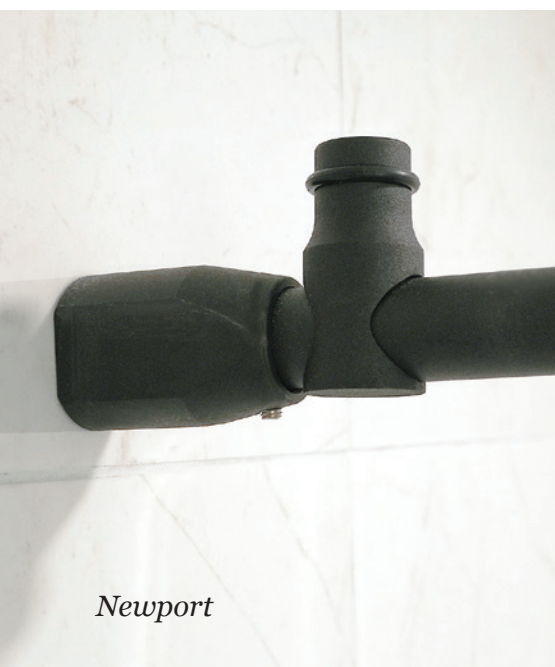

# Newport Barn Door Shower

Our Newport sliding barn door is an adjustable, frameless shower enclosure accommodating up to 60" openings, with a 30" fixed panel on the shower head side. The dual slider trolley system smoothly glides along a 1" diameter rod designed to carry 10mm tempered glass door.

*Newport*



## Newport Features

Dimensions 57" - 60" opening with 30" fixed panel, 76" OA height, 3/8" (10mm) glass

Pulls  ACM06312 (2)

Towel Bar (optional)  ACRO24

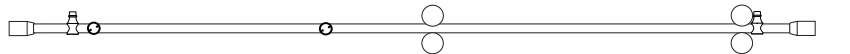
Hardware 

Finishes Satin Brass  Matte Black  Polished  Brushed 

Additional size options available  
Standard fit range is 56" - 60" opening



# Monterey Barn Door Shower

Our Monterey sliding barn door is an adjustable shower enclosure accommodating up to 60" openings, with a 30" fixed panel on the shower head side. Custom widths and heights can be provided if desired.



You can get any of our showers in Satin Brass

## Monterey Features

Dimensions 60" track, 30" fixed panel, 76" OA height, 3/8" (10mm) glass

Pulls  ACHU6308 (2)

Towel Bar (optional)  ACHU24

## Hardware

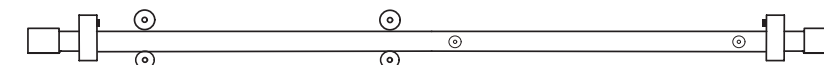

Finishes Satin Brass  Matte Black  Polished  Brushed 

Additional size options available  
Standard fit range is 56"-60" opening



# Santa Cruz By-pass Shower Door

Smooth gliding rollers and elegant lines frame this by-pass shower enclosure. Simple, space saving design creates a modern look and versatile shower operation.



## Santa Cruz Features

Dimensions 60" top track mounted, 78" OA height with (8mm) glass

Pulls AC099 Flush pull

Towel Bar ACMT6318 Towel Bar

### Hardware

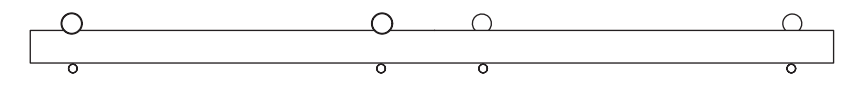

Finishes Satin Brass Matte Black Polished Brushed

Additional size options available  
Standard fit range is 56"-60" opening

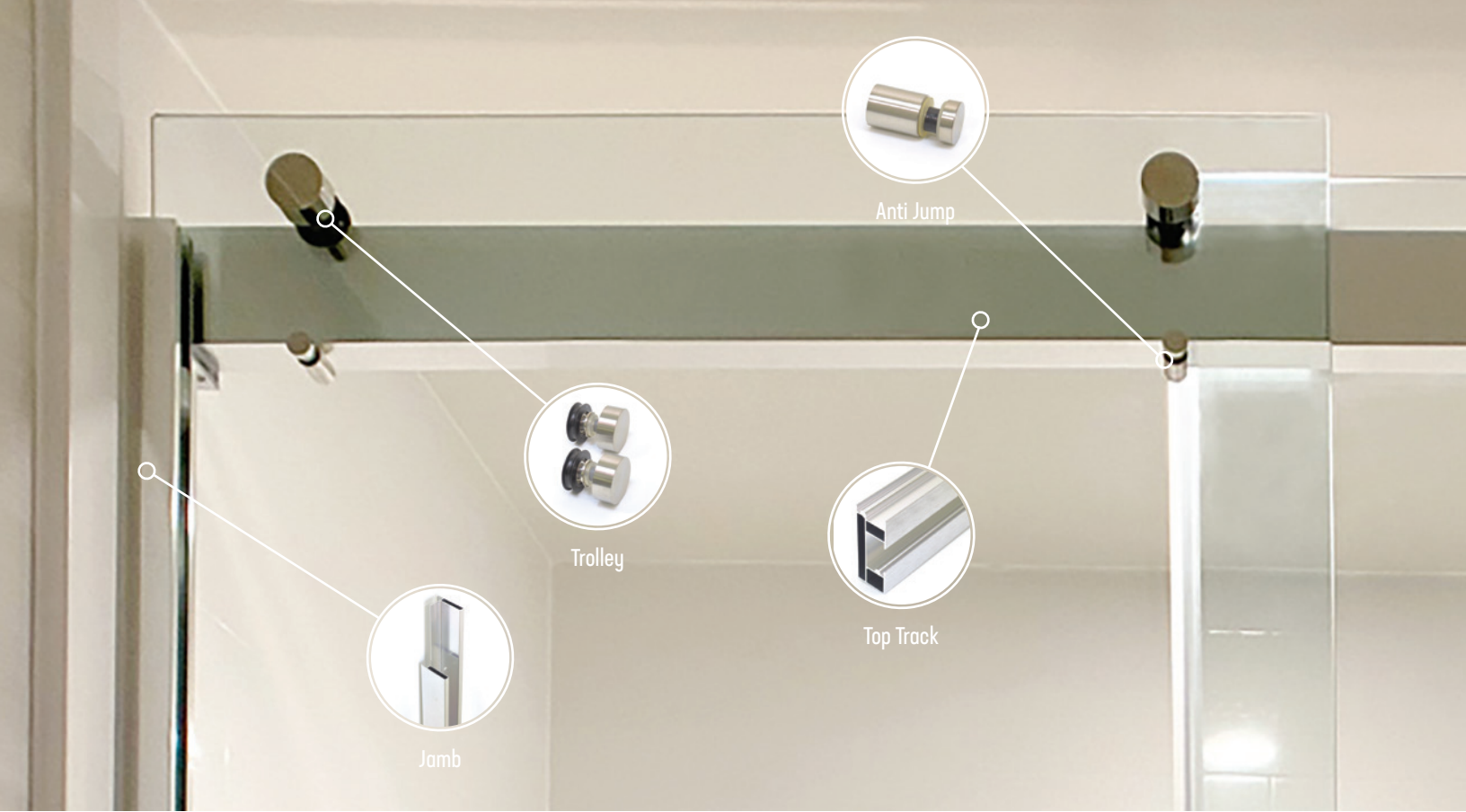

# Pasadena By-pass Shower Door

The most popular system in our collection, our Pasadena by-pass has clean lines and modern appeal with minimal hardware that instantly makes the room feel larger and accessible.

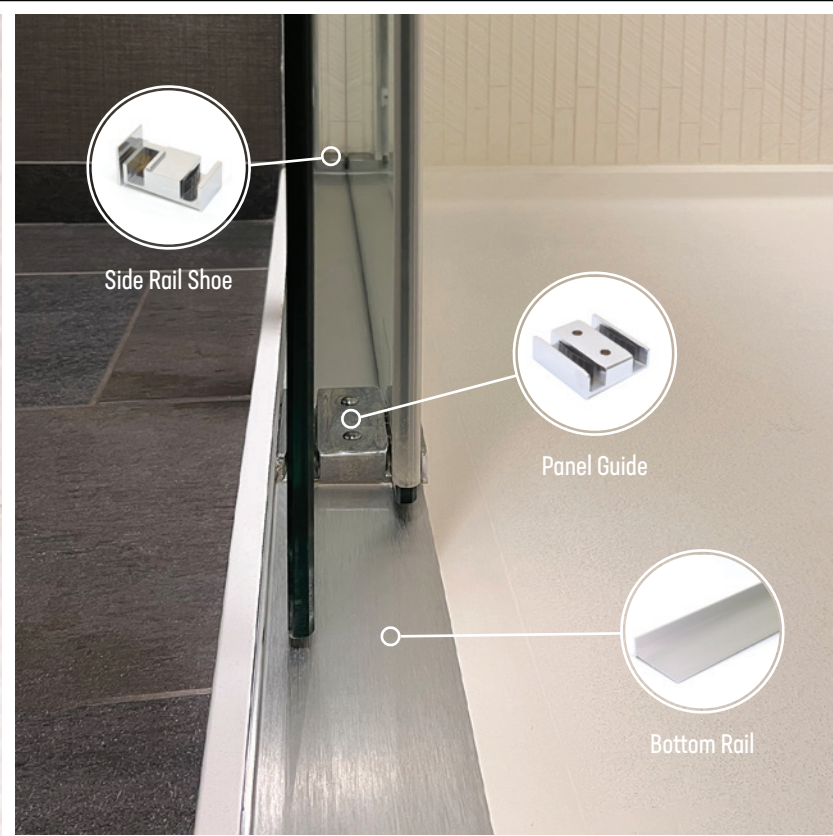
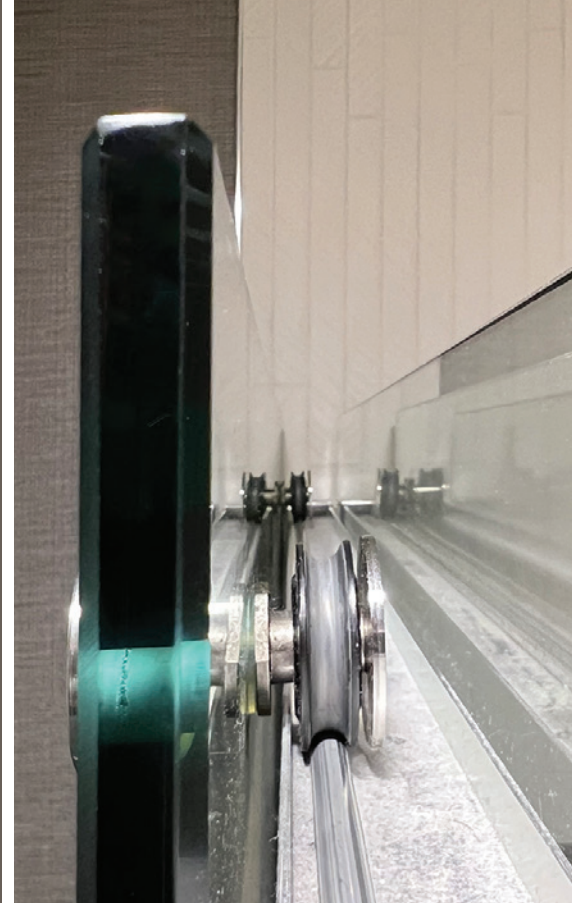

## Pasadena Features

Dimensions 60" top track mounted, 78" OA height with (10mm) glass

Towel Bars  ACPA6316 (2)

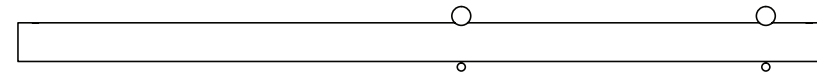
Hardware 

Finishes  Satin Brass  Matte Black  Polished  Brushed

**Additional size options available**  
Standard fit range is 56"-60" opening

Pasadena



# Fresno By-pass Shower Door

A classic by-pass system with concealed hangers offering a softer feel with two tubular towel bars and bowed track.

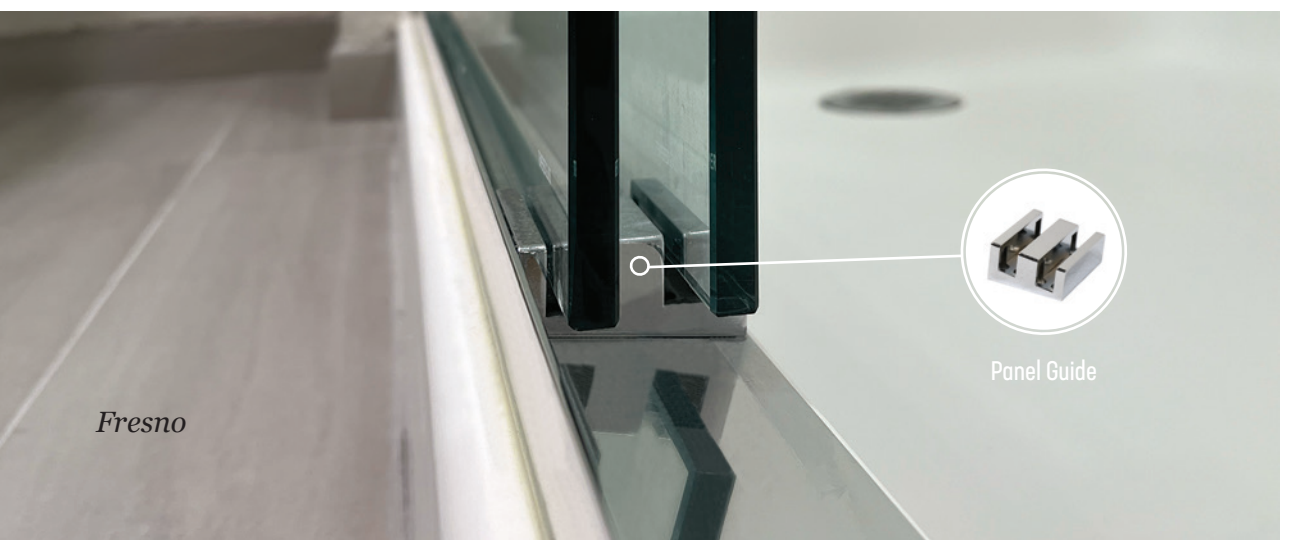
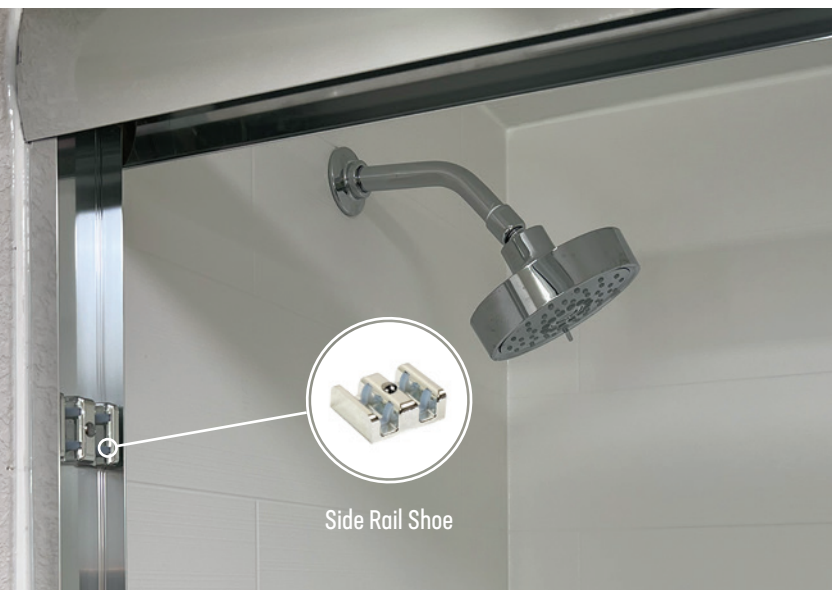

Fresno

## Fresno Features

Dimensions 60" top track, 78" OA height with (10mm) glass

Towel Bars  ACRO24 (2)

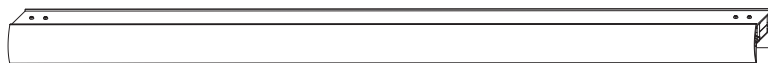
Hardware 

Finishes Satin Brass  Matte Black  Polished  Brushed 

Additional size options available  
Standard fit range is 56"-60" opening

# Calistoga By-pass Shower Door

Fully framed by-pass shower utilizing 1/4" (6mm) glass to fit on a 2" shower curb.

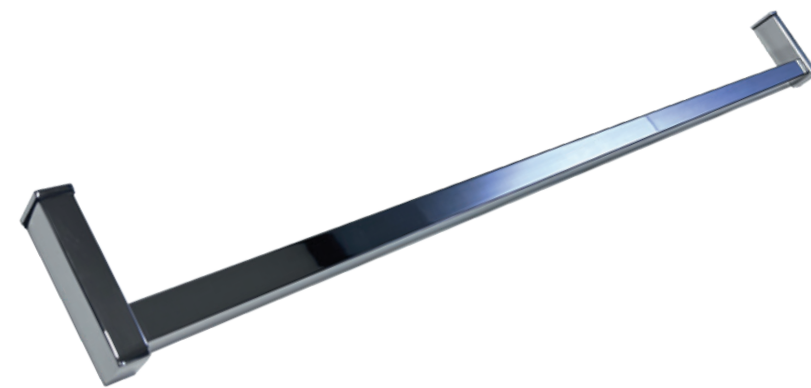
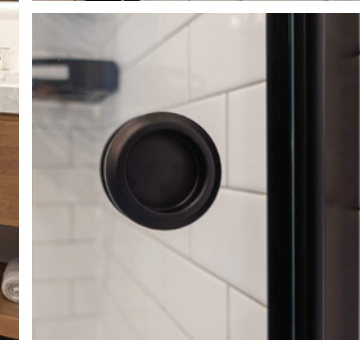

## Calistoga Features

Dimensions 78" OA height fits standard opening range of 54" - 60", 1/4" (6mm) glass

Towel Bar

Hardware



Finishes **Satin Brass** **Matte Black** **Polished** **Brushed**

Additional size options available  
Standard fit range is 56"-60" opening

# Sonoma By-pass Shower Door

Similar to our Santa Cruz, utilizing 1/4" (6mm) glass to fit on a 2" shower curb.

## Sonoma Features

Dimensions 78" OA height fits standard opening range of 54" - 60", 1/4" (6mm) glass

Pull AC099 Flush pull

Towel Bar

Hardware

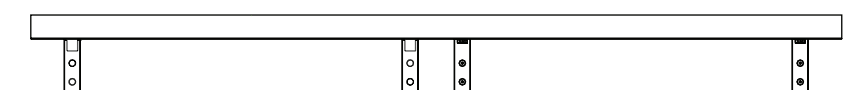

Finishes **Satin Brass** **Matte Black** **Polished** **Brushed**

Additional size options available  
Standard fit range is 56"-60" opening





# Malibu Custom Swing Shower

3/8" Swing Door Glass Shower Enclosures with multiple options.

Glass-to-wall hinge

Glass-to-wall hinge with fixed panel at strike side

Glass-to-glass

Glass-to-wall hinge with fixed panel

Glass-to-hinge with fixed panel at strike side

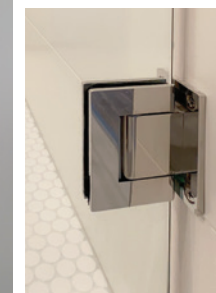
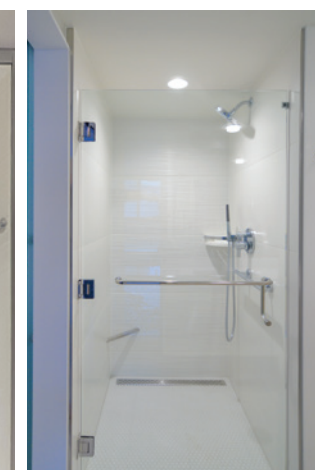

## Malibu Features

Dimensions 76" OA height with 3/8" (10mm) glass in 4 options

Pulls ACHU8X8, ACHU8X18, ACM06312, ACRO8X8, ACRO8X18

Hardware (Hinges) ACSD-H90, ACSD-HD90, ACSD-H180, ACSD-HD180, ACUC, ACUC3438, ACSDVS990, ACSDS990

Finishes Satin Brass ● Matte Black ● Polished ● Brushed ●

# Fremont Metal Frame Swing Shower Door

5/16" (8mm) fixed panel and 3/8" (10mm) Swing Door Glass Shower Enclosure with Multiple Options.

Pivot Hinge

Pivot Hinge with Fixed Panel at Strike Side



## Industry Metal Frame Swing Shower Door

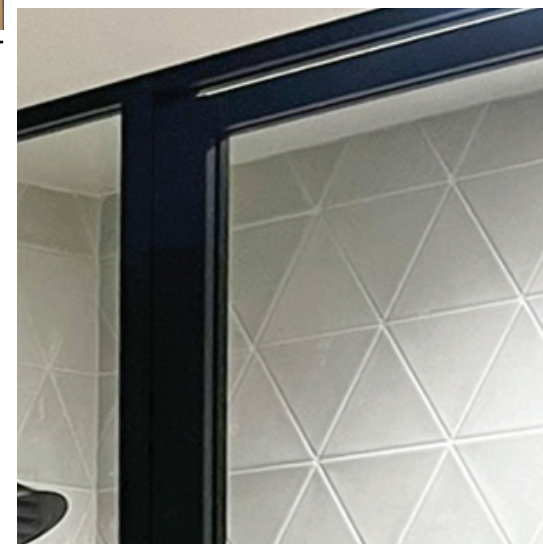

Available Finishes for our Metal Showers

Satin Brass  Matte Black  Polished  Brushed 

# AC SHOWER ENCLOSURES

## Barn Door Shower

### NEWPORT



57" - 60" opening with 30" fixed panel,  
76" OA height, 3/8" (10mm) glass

### MONTEREY



60" track, 30" fixed panel, 76" OA height,  
3/8" (10mm) glass

## Bypass Shower

### SANTA CRUZ



60" top track mounted to 78" tall  
side rails, 5/16" (8mm) glass

### PASADENA



78" OA height fits standard opening  
range of 54" - 60", 3/8" (10mm) glass

### FRESNO



78" OA height fits standard opening  
range of 54" - 60", 3/8" (10mm) glass

### SONOMA

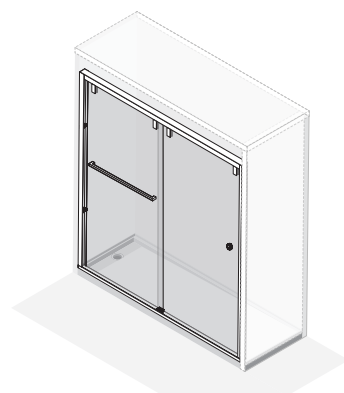

78" height fits standard opening range  
of 54" - 60", 1/4" (6mm) glass

## Bypass Shower

### CALISTOGA

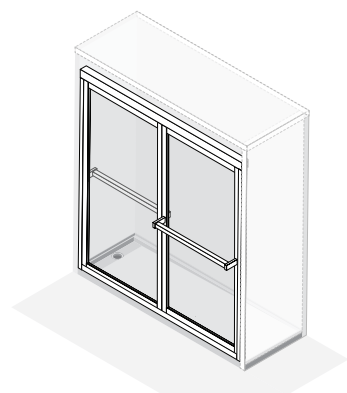

78" OA height fits standard opening  
range of 54" - 60", 1/4" (6mm) glass

## Swing Shower

### MALIBU

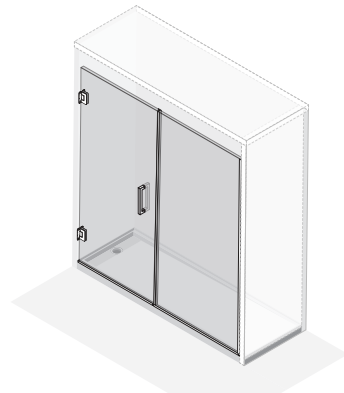

76" OA height, swing door,  
3/8" (10mm) glass

### FREMONT



76" OA height, pivot door, 5/16" fixed  
panel and 3/8" (10mm) glass door

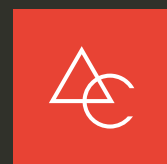

**Architectural  
Concepts**

18505 Longs Way  
Parker, CO 80134

**(888) 248 2724**

**[archconceptsllc.com](http://archconceptsllc.com)**

FEBRUARY 2025