



# MALIBU

## 3/8" SWING DOOR GLASS SHOWER ENCLOSURES

### SPECIFICATIONS

#### ELEVATION

- Option 1 Glass-to-wall hinge
- Option 2 Glass-to-wall hinge with fixed panel at strike side
- Option 3 Glass-to-glass
- Option 4 Glass-to-wall hinge with fixed panel
- Option 5 Glass-to-hinge with fixed panel at strike side

#### SIZE

76" OA Glass Height

#### PULLS AND TOWEL BARS

Page 6

#### HINGES

Page 7

#### HARDWARE

Page 8

*Custom sizes available upon request  
(6-8 weeks)*



**Architectural  
Concepts**

**O (888) 248 2724  
E info@archconceptsllc.com**

18505 Longs Way  
Parker, CO 80134

**archconceptsllc.com**

# MALIBU SWING SHOWER

## GLASS DOOR ELEVATIONS

GLASS-TO-WALL HINGE

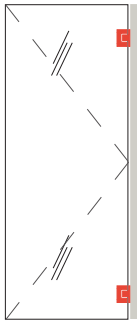

ELEVATION OPTION 1

GLASS-TO-WALL HINGE W/ FIXED PANEL AT STRIKE SIDE

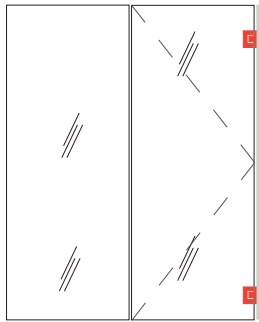

ELEVATION OPTION 2

GLASS-TO-GLASS HINGE WITH FIXED PANEL

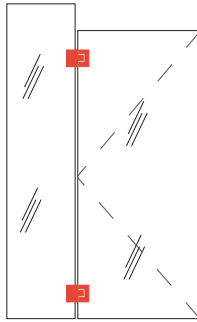

ELEVATION OPTION 3

Required: Custom quote for structural analysis

GLASS-TO-WALL HINGE WITH FIXED PANEL

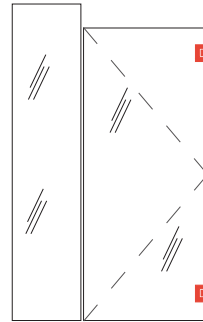

ELEVATION OPTION 4

Required: Custom quote for structural analysis

GLASS-TO-GLASS HINGE WITH FIXED PANEL AT STRIKE SIDE

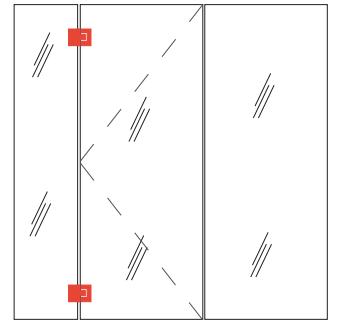

ELEVATION OPTION 5

Required: Custom quote for structural analysis

## GLASS DOOR AND PANEL DIMENSIONS

36" MAX. DOORS [32" AND LARGER REQUIRE 3 HINGES]

PLAN - OPTION 1

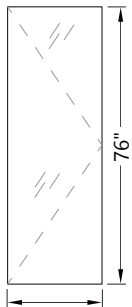

PLAN - OPTION 2

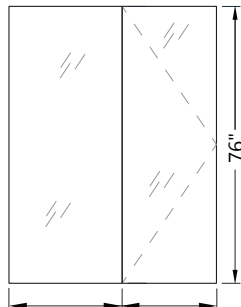

PLAN - OPTION 3

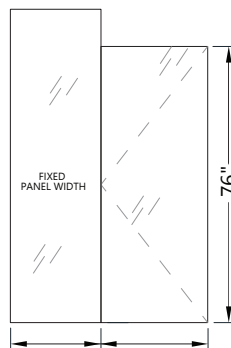

PLAN - OPTION 4

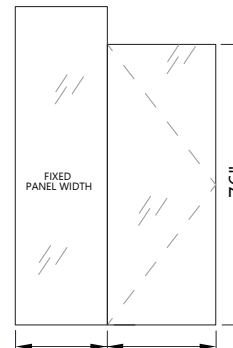

PLAN - OPTION 5

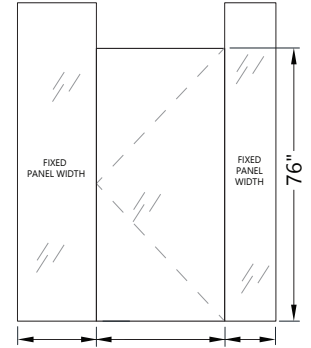

NO HEIGHT RESTRICTIONS. HEIGHT MAY EXTEND TO BOTTOM OF CEILING OR WITH TOP OF DOOR  
Custom quote for structural analysis is required for Options 3 & 4

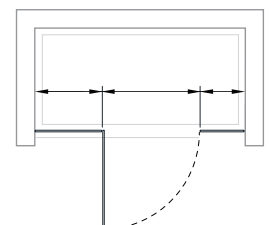
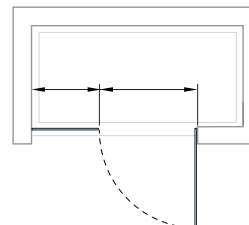
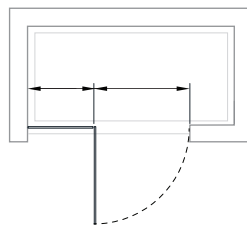
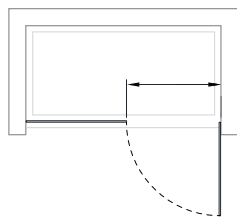
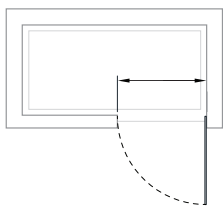

**Architectural Concepts**

(888) 248 2724 | (720) 259 5358 | info@archconceptsllc.com | 18505 Longs Way, Parker, CO 80134 | archconceptsllc.com

<https://www.archconceptsllc.com/products/shower-enclosures/swing-door/>

# MALIBU SWING SHOWER

## 76" OA ENCLOSURE HEIGHT SHOWER DOORS

28" [711mm]	30" [762mm]	32" [813mm]	28" [711mm]	30" [762mm]	32" [813mm]
<b>PART #</b> ACSD-28762HI2HO	<b>PART #</b> ACSD-30762HI2HO	<b>PART #</b> ACSD-32762HI2HO-HD	<b>PART #</b> ACSD-28762HI3HO	<b>PART #</b> ACSD-30762HI3HO	<b>PART #</b> ACSD-32762HI3HO-HD
<b>SIZE</b> 28" x 75 9/16"	<b>SIZE</b> 30" x 75 9/16"	<b>SIZE</b> 32" x 75 9/16"	<b>SIZE</b> 28" x 75 9/16"	<b>SIZE</b> 30" x 75 9/16"	<b>SIZE</b> 32" x 75 9/16"
<b>HINGE</b> ACSD-H90 (2 std hinges)	<b>HINGE</b> ACSD-H90 (2 std hinges)	<b>HINGE</b> ACSD-HD90 (2 HD hinges)	<b>HINGE</b> ACSD-H90 (2 std hinges)	<b>HINGE</b> ACSD-H90 (2 std hinges)	<b>HINGE</b> ACSD-HD90 (2 HD hinges)
<b>PULL SERIES</b> 8x8 MO/HU/RO	<b>PULL SERIES</b> 8x8 MO/HU/RO	<b>PULL SERIES</b> 8x8 MO/HU/RO	<b>PULL SERIES</b> 8X18 RO/HU	<b>PULL SERIES</b> 8X18 RO/HU	<b>PULL SERIES</b> 8X18 RO/HU

## 3/8" CLEAR FIXED PANELS

<b>PART #</b> ACSD-PNL2878X7512	<b>PART #</b> ACSD-PNL2678X7512	<b>PART #</b> ACSD-PNL2478X7512	<b>PART #</b> ACSD-PNL2278X7512	<b>PART #</b> ACSD-PNL1678X7512	<b>PART #</b> ACSD-PNL1478X7512	<b>PART #</b> ACSD-PNL1278X7512	<b>PART #</b> ACSD-PNL1078X7512
<b>SIZE</b> 28 7/8" x 75 1/2"	<b>SIZE</b> 26 7/8" x 75 1/2"	<b>SIZE</b> 24 7/8" x 75 1/2"	<b>SIZE</b> 22 7/8" x 75 1/2"	<b>SIZE</b> 16 7/8" x 75 1/2"	<b>SIZE</b> 14 7/8" x 75 1/2"	<b>SIZE</b> 12 7/8" x 75 1/2"	<b>SIZE</b> 10 7/8" x 75 1/2"



**Architectural Concepts**

(888) 248 2724 | (720) 259 5358 | [info@archconceptsllc.com](mailto:info@archconceptsllc.com) | 18505 Longs Way, Parker, CO 80134 | [archconceptsllc.com](http://archconceptsllc.com)

<https://www.archconceptsllc.com/products/shower-enclosures/swing-door/>

Page 3 of 8

Revised 05-23-24

# MALIBU SWING SHOWER

FIT MATRIX 1 1/2" U-CHANNEL (STANDARD APPLICATION)

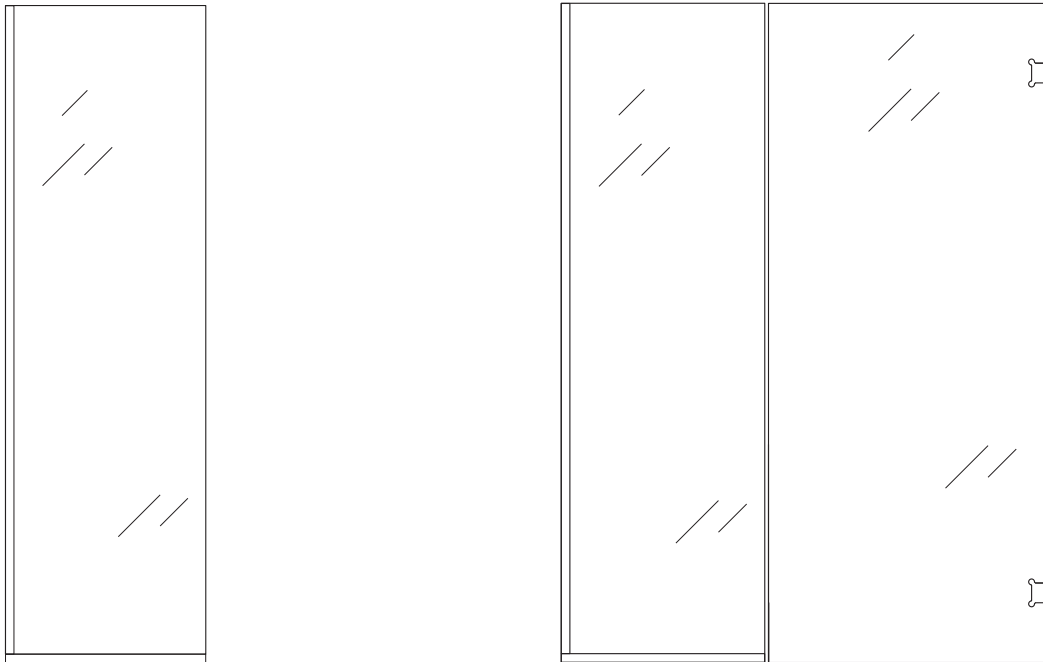

## FIXED PANEL GLASS

1 1/2" U CHANNEL PART #  
ACUC

- PANEL SIZES**  
 28 7/8" x 75 1/2"  
 26 7/8" x 75 1/2"  
 24 7/8" x 75 1/2"  
 22 7/8" x 75 1/2"  
 16 7/8" x 75 1/2"  
 14 7/8" x 75 1/2"  
 12 7/8" x 75 1/2"  
 10 7/8" x 75 1/2"

## ACUC 1 1/2" U-CHANNEL

FINISHED OPENING		FINISHED OPENING	
57 3/8" - 58 1/2"		45 3/8" - 46 1/2"	
DOOR	PANEL	DOOR	PANEL
28"	28 7/8"	28"	16 7/8"
30"	26 7/8"	30"	14 7/8"
32"	24 7/8"	32"	12 7/8"

## 1 1/2" CHANNEL (NON-STANDARD) OPENINGS

DOOR	PANEL	FITS
32"	26 7/8"	59 3/8" - 60 1/2"
32"	28 7/8"	61 3/8" - 62 1/2"
32"	22 7/8"	55 3/8" - 56 1/2"
32"	16 7/8"	49 3/8" - 50 1/2"
32"	14 7/8"	47 3/8" - 48 1/2"
32"	10 7/8"	43 3/8" - 44 1/2"
30"	28 7/8"	59 3/8" - 60 1/2"
30"	24 7/8"	55 3/8" - 56 1/2"
30"	22 7/8"	53 3/8" - 54 1/2"
30"	16 7/8"	47 3/8" - 48 1/2"
30"	12 7/8"	43 3/8" - 44 1/2"
30"	10 7/8"	41 3/8" - 42 1/2"
28"	26 7/8"	55 3/8" - 56 1/2"
28"	24 7/8"	53 3/8" - 54 1/2"
28"	14 7/8"	43 3/8" - 44 1/2"
28"	12 7/8"	41 3/8" - 42 1/2"
28"	10 7/8"	39 3/8" - 40 1/2"



**Architectural Concepts**

(888) 248 2724 | (720) 259 5358 | info@archconceptsllc.com | 18505 Longs Way, Parker, CO 80134 | archconceptsllc.com

<https://www.archconceptsllc.com/products/shower-enclosures/swing-door/>

Page 4 of 8

Revised 05-23-24

# MALIBU SWING SHOWER

FIT MATRIX 3/4" LOW PROFILE U-CHANNEL

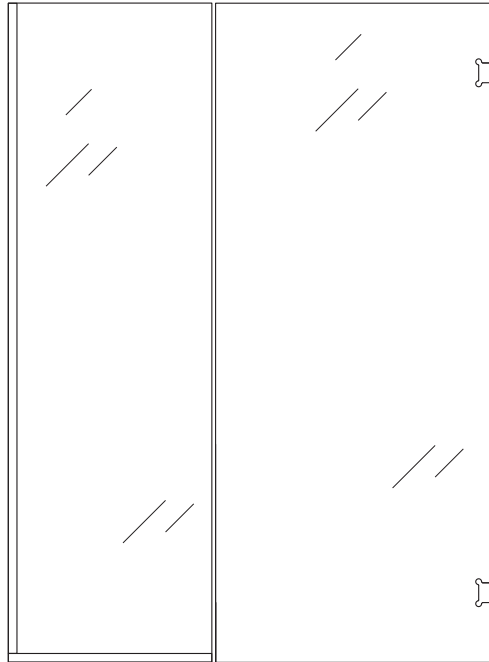

## FIXED PANEL GLASS

**3/4" U-CHANNEL PART #**  
ACUC3438

- PANEL SIZES**  
 28 7/8" x 75 1/2"  
 26 7/8" x 75 1/2"  
 24 7/8" x 75 1/2"  
 22 7/8" x 75 1/2"  
 16 7/8" x 75 1/2"  
 14 7/8" x 75 1/2"  
 12 7/8" x 75 1/2"  
 10 7/8" x 75 1/2"

## ACUC3438 3/4" U-CHANNEL LOW PROFILE

FINISHED OPENING		FINISHED OPENING	
57 3/8" - 57 7/8"		45 3/8" - 45 7/8"	
DOOR	PANEL	DOOR	PANEL
28"	28 7/8"	28"	16 7/8"
30"	26 7/8"	30"	14 7/8"
32"	24 7/8"	32"	12 7/8"

## 3/4" CHANNEL NON-STANDARD OPENINGS

DOOR	PANEL	FITS
32"	26 7/8"	59 3/8" - 59 7/8"
32"	28 7/8"	61 3/8" - 61 7/8"
32"	22 7/8"	55 3/8" - 55 7/8"
32"	16 7/8"	49 3/8" - 49 7/8"
32"	14 7/8"	47 3/8" - 47 7/8"
32"	10 7/8"	43 3/8" - 43 7/8"
30"	28 7/8"	59 3/8" - 59 7/8"
30"	24 7/8"	55 3/8" - 55 7/8"
30"	22 7/8"	53 3/8" - 53 7/8"
30"	16 7/8"	47 3/8" - 47 7/8"
30"	12 7/8"	43 3/8" - 43 7/8"
30"	10 7/8"	41 3/8" - 41 7/8"
28"	26 7/8"	55 3/8" - 55 7/8"
28"	24 7/8"	53 3/8" - 53 7/8"
28"	14 7/8"	43 3/8" - 43 7/8"
28"	12 7/8"	41 3/8" - 41 7/8"
28"	10 7/8"	39 3/8" - 39 7/8"



**Architectural Concepts**

(888) 248 2724 | (720) 259 5358 | info@archconceptsllc.com | 18505 Longs Way, Parker, CO 80134 | archconceptsllc.com

<https://www.archconceptsllc.com/products/shower-enclosures/swing-door/>

Page 5 of 8

Revised 05-23-24

# MALIBU SWING SHOWER

## PULLS AND TOWEL BARS



Matte Black



Polished Chrome



Brushed Stainless



Satin Brass

Custom finishes available

### ACHU8X8



Square Tubing 8" BTB Pull

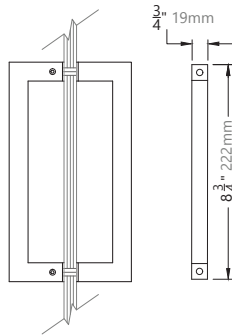

### ACHU8X18



Square Tubing 8" x 18" Handle/TB Combo

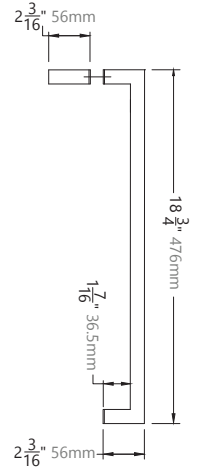

### ACM06312



8" CTC Ladder Pull - 12" OA length

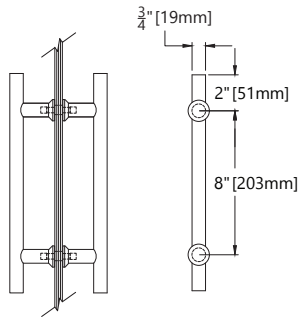

### ACR08X8



Tubular 8" BTB Pull

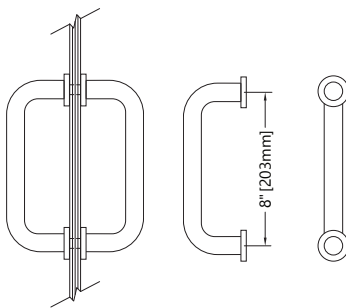

### ACR08X18



Tubular 8"x18" Handle/TB Combo

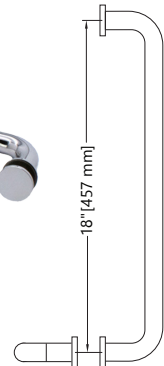

**Architectural Concepts**

(888) 248 2724 | (720) 259 5358 | info@archconceptsllc.com | 18505 Longs Way, Parker, CO 80134 | archconceptsllc.com

<https://www.archconceptsllc.com/products/shower-enclosures/swing-door/>

Page 6 of 8

Revised 09-14-23

# MALIBU SWING SHOWER

## HARDWARE



Matte Black



Polished Chrome



Brushed Stainless



Satin Brass

*Custom finishes available*

### ACSD-H90

Wall-to-Glass Hinge

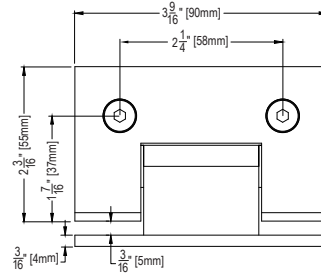

### ACSD-HD90

Heavy Duty Wall-to-Glass Hinge

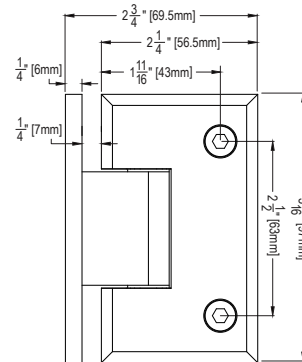

### ACSD-H180

Glass-to-Glass Hinge

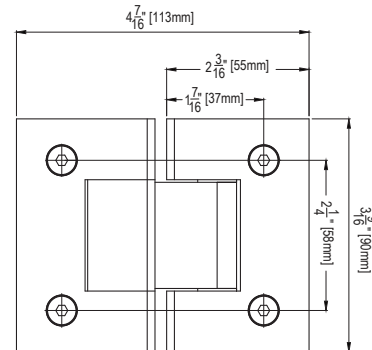

### ACSD-HD180

Heavy Duty Glass-to-Glass Hinge

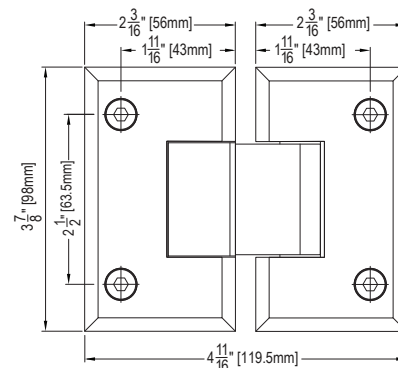

NOTE: Depending on application, all shower enclosures will come with Wall-to-Glass Hinge or Glass-to-Glass Hinge



**Architectural Concepts**

(888) 248 2724 | (720) 259 5358 | [info@archconceptsllc.com](mailto:info@archconceptsllc.com) | 18505 Longs Way, Parker, CO 80134 | [archconceptsllc.com](http://archconceptsllc.com)

<https://www.archconceptsllc.com/products/shower-enclosures/swing-door/>

Page 7 of 8

Revised 09-14-23



# MALIBU SWING SHOWER

HARDWARE

**ACUC**  
1 1/2" Aluminum U-Channel

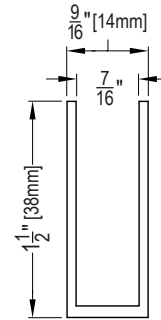
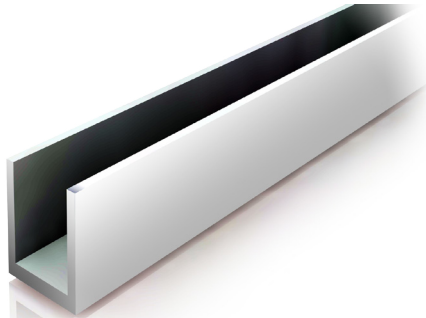

**ACUC3438**  
3/4" Aluminum U-Channel

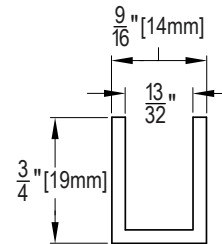
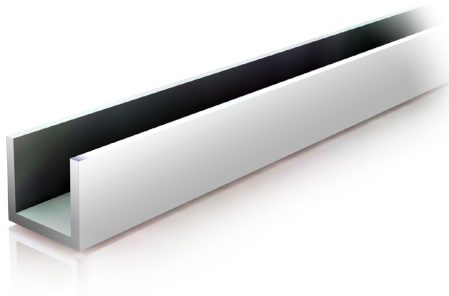

**ACSDVS990**  
Vertical Seal

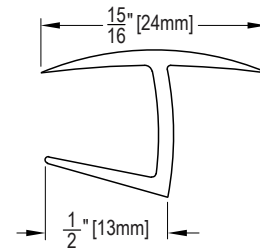

**ACSDS990**  
Bottom Sweep

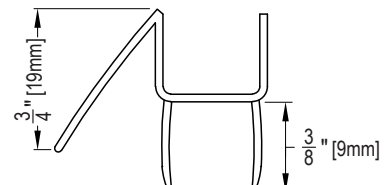

NOTE: Depending on application, all shower enclosures will come with Wall-to-Glass Hinge or Glass-to-Glass Hinge



**Architectural Concepts**

(888) 248 2724 | (720) 259 5358 | [info@archconceptsllc.com](mailto:info@archconceptsllc.com) | 18505 Longs Way, Parker, CO 80134 | [archconceptsllc.com](http://archconceptsllc.com)

<https://www.archconceptsllc.com/products/shower-enclosures/swing-door/>

Page 8 of 8

Revised 09-14-23